

System Board D2530 for Econel 200 S2

Technical Manual

Edition November 2006

Comments... Suggestions... Corrections...

The User Documentation Department would like to know your opinion of this manual. Your feedback helps us optimize our documentation to suit your individual needs.

Fax forms for sending us your comments are included in the back of the manual.

There you will also find the addresses of the relevant User Documentation Department.

Certified documentation according to DIN EN ISO 9001:2000

To ensure a consistently high quality standard and user-friendliness, this documentation was created to meet the regulations of a quality management system which complies with the requirements of the standard DIN EN ISO 9001:2000.

cognitas. Gesellschaft für Technik-Dokumentation mbH
www.cognitas.de

Copyright and Trademarks

Copyright © 2006 Fujitsu Siemens Computers GmbH.

All rights reserved.

Delivery subject to availability; right of technical modifications reserved.

All hardware and software names used are trademarks of their respective manufacturers.

Contents

1	Introduction	5
2	Important notes	7
2.1	Notes on safety	7
2.2	CE Certificate	10
2.3	Environmental Protection	11
3	Features	13
3.1	Overview	13
3.2	Main memory	15
3.3	PCI bus	16
3.4	Screen resolution	18
3.5	Temperature / system monitoring	18
3.6	Connectors and jumpers	20
3.6.1	External connectors	22
4	Replacing the lithium battery	25
	Abbreviations	27

1 Introduction

This technical manual describes the system board D2530, which can be equipped with one or two Intel® processors.

Further information about drivers is provided in the readme files on the hard disk, on the supplied "ServerSupport" or "ServerStart" CDs.

You will find further information in the BIOS description.

Notational conventions

The meanings of the symbols and fonts used in this manual are as follows:



<i>italics</i>	indicates commands, menu items, file and path names or software programs
fixed font	indicate system output on the monitor
semi-bold fixed font	indicates values to be entered through the keyboard
[Key symbol]	indicates keys according to their representation on the keyboard If capital letters are to be entered explicitly, then the Shift key is shown, e.g. [SHIFT] - [A] for A. If two keys need to be pressed at the same time, then this is shown by placing a hyphen between the two key symbols.
"quotation marks"	indicates names and terms that are being emphasized.
▶	indicates an operation that to be performed
 CAUTION!	indicates warnings, which, if ignored, will endanger your health, destroy the system or lead to the loss of data.
	indicates additional information, notes and tips

Table 1: Notational conventions

2 Important notes

In this chapter you will find essential information regarding safety when working with your server.



CAUTION!

With the system board installed you must open the system to access the system board. How to access the system board of your system is described in the appropriate service supplement.

When handling the system board, refer to the specific notes on safety in the operating manual and/or service supplement for the respective server.

2.1 Notes on safety



CAUTION!

- The actions described in these instructions should only be performed by authorized, qualified personnel. Equipment repairs should only be performed by qualified staff. Any failure to observe the guidelines in this manual, and any unauthorized openings and improper repairs could expose the user to risks (electric shock, fire hazards) and could also damage the equipment. Please note that any unauthorized openings of the device will result in the invalidation of the warranty and exclusion from all liability.
- Transport the device only in the antistatic original packaging or in packaging that protects it from knocks and jolts.
- Only install expansions that are allowed for the system board. If you install other expansions, you may damage the requirements and rules governing safety and electromagnetic compatibility or your system. Information on which system expansions are suitable can be obtained from the customer service centre or your sales outlet.
- The warranty expires if the device is damaged during the installation or replacement of system expansions.



- Components can become very hot during operation. Ensure you do not touch components when making extensions to the system board. There is a danger of burns!
- Transmission lines to peripheral devices must be adequately shielded.
- To the LAN wiring the requirements apply in accordance with the standards EN 50173 and EN 50174-1/2. As minimum requirement the use of a protected LAN line of category 5 for 10/100 MBps Ethernet, and/or of category 5e for Gigabit Ethernet is considered. The requirements of the specification ISO/IEC 11801 are to be considered.
- Never connect or disconnect data transmission lines during a storm (lightning hazard).

Batteries



CAUTION!

- Incorrect replacement of lithium battery may lead to a risk of explosion. The batteries may only be replaced with identical batteries or with a type recommended by the manufacturer.

It is essential to observe the instructions in [chapter “Replacing the lithium battery”](#).

Modules with electrostatic-sensitive components

Systems and components that might be damaged by electrostatic discharge (ESD) are marked with the following label:

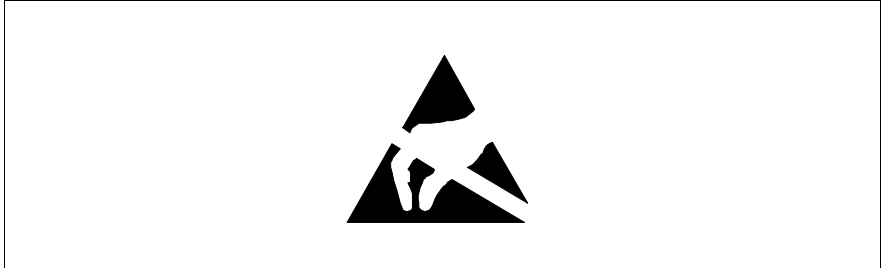

Figure 1: ESD label

When you handle components fitted with ESDs, you must observe the following points under all circumstances:

- You must always discharge yourself of static charges (e.g. by touching a grounded object) before working.
- The equipment and tools you use must be free of static charges.
- Remove the power plug from the power socket before inserting or removing boards containing ESDs.
- Always hold boards with ESDs by their edges.
- Never touch pins or conductors on boards fitted with ESDs.
- Use a grounding cable designed for this purpose to connect yourself to the system unit as you install/deinstall the board.
- Place all components on a static-safe base.



You will find a detailed description for handling ESD components in the relevant European or international standards (EN 61340-5-1, ANSI/ESD S20.20).

Notes about boards

- During installation/deinstallation of the system board, observe the specific instructions described in the service manual for the server.
- Remove the plug from the mains outlet so that system and system board are totally disconnected from the mains voltage.
- To prevent damage to the system board, the components and conductors on it, please take great care when you insert or remove boards. Take great care to ensure that extension boards are slotted in straight, without damaging components or conductors on the system board, or any other components, for example EMI spring contacts
- Be careful with the locking mechanisms (catches, centring pins etc.) when you replace the system board or components on it, for example memory modules or processors.
- Never use sharp objects (screwdrivers) for leverage.

2.2 CE Certificate



The shipped version of this board complies with the requirements of the EEC directive 89/336/EEC "Electromagnetic compatibility".

Compliance was tested in a typical PRIMERGY configuration.

2.3 Environmental Protection

Environmentally friendly product design and development

This product has been designed in accordance with standards for "environmentally friendly product design and development". This means that the designers have taken into account important criteria such as durability, selection of materials and coding, emissions, packaging, the ease with which the product can be dismantled and the extent to which it can be recycled.

This saves resources and thus reduces the harm done to the environment.

Notes on saving energy

Devices that do not have to be on permanently should not be switched on until they need to be used and should be switched off during long breaks and on completion of work.

Notes on packaging

Please do not throw away the packaging. We recommend that you do not throw away the original packaging in case you need it later for transporting.

Notes on dealing with consumables

Please dispose batteries in accordance with local government regulations.

Do not throw batteries and accumulators into the household waste. They must be disposed of in accordance with local regulations concerning special waste.

All batteries containing pollutants are marked with a symbol (a crossed-out rubbish bin on wheels). In addition, the marking is provided with the chemical symbol of the heavy metal decisive for the classification as a pollutant:

Cd Cadmium

Hg Mercury

Pb Lead

Notes on labeling plastic housing parts

Please avoid attaching your own labels to plastic housing parts wherever possible, since this makes it difficult to recycle them.

Returning, recycling and disposal

The device may not be disposed of with household rubbish. This appliance is labelled in accordance with European Directive 2002/96/EC concerning used electrical and electronic appliances (waste electrical and electronic equipment - WEEE).

The guideline determines the framework for the return and recycling of used appliances as applicable throughout the EU. To return your used device, please use the return and collection systems available to you. You will find further information on this at www.fujitsu-siemens.com/recycling.

For details on returning and reuse of devices and consumables within Europe, refer to the “Returning used devices” manual, or contact your Fujitsu Siemens Computers branch office/subsidiary or our recycling centre in Paderborn:

Fujitsu Siemens Computers
Recycling Center
D-33106 Paderborn

Tel. +49 5251 8 18010

Fax +49 5251 8 18015

3 Features

3.1 Overview

Processors

- 2 x Intel® Xeon™ Dual Core processors
- 2 processor sockets Dual LGA771 for Intel® Xeon™ Dual Core processor with 1333/1066/667 MHz front side bus
- supports Intel® Extended Memory 64 Technology (EM64T)
- supports Intel® Hyper-Threading Technology (H.T.), except: 5100 series

Main memory

- 4 slots for main memory FBD533/PC2-4200F Fully Buffered DIMM memory modules with 512 MB, 1Gbyte and 2Gbyte
- maximum 8 Gbyte of memory
- minimum 512 MB
- ECC multiple bit error detection and single bit error correction
- memory scrubbing function
- Single Device Data Correction (SDDC) function (Chipkill™)

Chipsets on the system board

- Intel® 5000V chipset Memory Controller Hub (MCH)
- Intel® 6321 I/O Controller Hub (ICH) with integrated GBit LAN
- Intel® Single 1 GB PHY 82564EB onboard
- VGA controller (ATI® ES1000) onboard with 32 MB RAM memory
- 1 MBYTE Flash EPROM für:
 - System BIOS
 - Onboard Video
 - Onboard LAN
 - Onboard LSI Software RAID
 - Onboard SATA
- system management controller (temperature, voltages, fans) W83793G

Internal connectors

- floppy disk
- 1 IDE primary
- 6 SATA connectors
- SATA-HDD access (HDLED)
- 2 USB connectors
- 1 serial port connector (COM2)
- PC98 connector
- 1 parallel port connector (LPT1)
- front panel
- main power connector (12V, -12V, 5V, 3.3V and 5V auxiliary)
- 12V (CPU) power connector
- 2 CPU fans
- 1 rear fan
- BPSMB connector
- BPSMB connector
- RAID key

External connectors

- 1 serial port (COM1)
- 2 PS/2 interfaces for keyboard and mouse
- 2 USB 2.0 ports with 480 Mbits/s (rear)
- 1 VGA port
- 1 RJ45 LAN port

PCI slots

- 3 x PCI-X (133/100 MHz)
- 1 x PCI 33 MHz
- 1 x PCI-Express x16 slot (x8 wired)
- 1 x PCI-Express x8 slot (x4 wired)

BIOS features

- AMI (American Megatrend BIOS)

Form factor

12" x 10.5"

3.2 Main memory

The system board supports up to 8 Gbyte main memory. 4 slots (2 banks with 2 modules) are available for the main memory. Each memory bank can be populated with 512 Mbyte, 1 Gbyte or 2 Gbyte FBD533/PC2-4200F Fully Buffered DIMM memory modules.

ECC with memory scrubbing and with the Single Device Data Correction (SDDC) function is supported.



You will find the descriptions how to install memory modules in the Options Guide of your server.

Module population

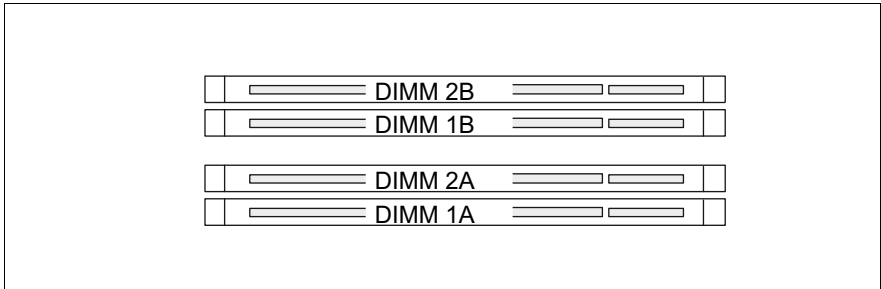

Figure 2: Main memory

- If the memory modules are populated in pairs, each pair must consist of identical memory modules (2-way interleaved mode)
- The module capacity between pairs can differ: pair 2A/2B can be populated with two 512 Mbyte modules and pair 1A/1B with two 1 Gbyte modules.

Following table shows the mandatory population order:

	DIMM 1A	DIMM 2A	DIMM 1B	DIMM 2B
single channel	populated	empty	empty	empty
dual channel	populated	empty	populated	empty
	populated	populated	populated	populated

3.3 PCI bus

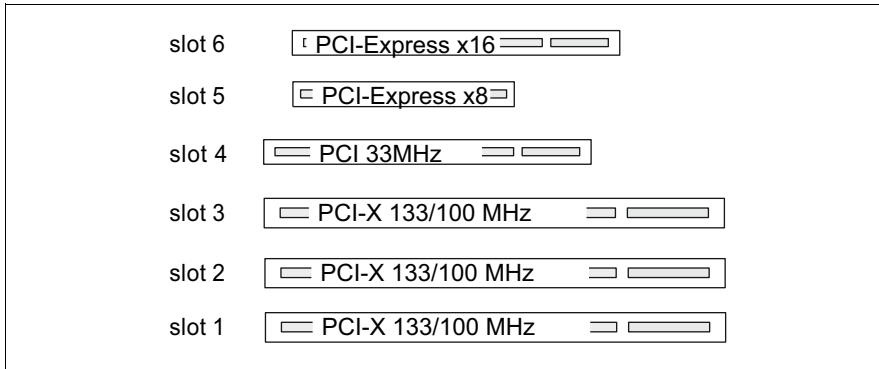

Figure 3: PCI slots

PCI slots

The following table shows an overview of the PCI slots:

PCI slot	64Bit/ 32Bit	Frequency in MHz	Description
1		133/100	PCI-X bus slot, IOOP
2		133/100	PCI-X bus slot, IOOP
3		133/100	PCI-X bus slot, IOOP
4	32 Bit	33	PCI bus slot
5			PCI-Express x8 slot (x4 accessed)
6			PCI-Express x16 slot (x8 accessed)

PCI IRQ Line x - Assignment of the PCI interrupts

PCI IRQ Line x defines which ISA interrupts are used for the separate PCI slots.

If you select *Auto* in the BIOS setup, the interrupts are assigned automatically and no further settings are required.

Multifunctional PCI boards or boards with an integrated PCI-to-PCI bridge can use several PCI interrupts (INTA#, INTB#, INTC#, INTD#). Monofunctional PCI boards (default) only use one PCI interrupt (INTA#) per PCI slot.

The PCI interrupts INTA#, INTB#, INTC# and INTD# are available for each PCI slot (except the PCI-Express slots).

The same interrupt can be assigned simultaneously to several PCI boards. You should avoid this condition due to reduced performance.

If you use a setting other than *Auto*, the Plug&Play functionality of the system BIOS for the corresponding PCI boards is deactivated.

Auto The PCI interrupts are assigned automatically in accordance with the Plug&Play guidelines.

Disabled No ISA interrupt is assigned to the PCI interrupt.

3, 4, 5, 6, 7, 9, 10, 11, 12, 14, 15

The selected ISA interrupt is assigned to the PCI interrupt. You may not select an ISA interrupt that is used by a component on the system board (e.g. controller) or an ISA board.

Device	Bus	IDsel	INTA	INTB	INTC	INTD
Slot 1	PCI-X	19	PXIRQ8	PXIRQ9	PXIRQ10	PXIRQ11
Slot 2	PCI-X	18	PXIRQ4	PXIRQ5	PXIRQ6	PXIRQ7
Slot 3	PCI-X	17	PXIRQ0	PXIRQ1	PXIRQ2	PXIRQ3
Slot 4	PCI	17	PIRQA	PIRQB	PIRQC	PIRQD
Slot 5	PCI-Express					
Slot 6	PCI-Express					
VGA	PCI	18	PIRQB			
LAN			PIRQE			
USB UHCI Controller #0			PIRQA			
USB UHCI Controller #1			PIRQD			
USB UHCI Controller #2			PIRQC			
USB UHCI Controller #3			PIRQA			
USB 2.0 EHCI			PIRQH			

3.4 Screen resolution

Depending on the operating system used the screen resolutions in the following table refer to the screen controller on the system board. If you are using an external screen controller, you will find details of supported screen resolutions in the operating manual or technical manual supplied with the controller.

Screen resolution	Possible refresh rates (Hz) ¹⁾	Color depth (bits pro pixel, bpp)
640x480	60, 72, 75, 85, 90, 100, 120, 160, 200	8, 16 ²⁾ , 32 ²⁾
800x600	60, 70, 72, 75, 85, 90, 100, 120, 160, 200	8, 16 ²⁾ , 32 ²⁾
1024x768	60, 70, 72, 75, 85, 90, 100, 120, 140, 150, 160, 200	8, 16 ²⁾ , 32 ²⁾
1152x864	43, 47, 60, 70, 75, 80, 85, 100, 120, 150, 160	8, 16 ²⁾ , 32 ²⁾
1280x1024	60, 70, 74, 75, 85, 90, 100, 120	8, 16 ²⁾ , 32 ²⁾
1600x1200	52, 58, 60, 66, 75	8, 16 ²⁾ , 32 ²⁾

- 1) depending on the operating system specific video drivers
- 2) depending on the selected refresh rate and the modified video memory clock

3.5 Temperature / system monitoring

Temperature and system monitoring aim to reliably protect the computer hardware against damage caused by overheating. In addition, any unnecessary noise is also prevented by reducing the fan speed, and information is provided about the system status.

The temperature and system monitoring is controlled by an onboard controller.

The following functions are supported:

Temperature monitoring

Measurement of the processor temperature, measurement of the ambient temperature by a temperature sensor on the LED board.

Fan monitoring

Fans that are no longer available, blocked or sticky fans are detected.

Fan control

The fans are controlled according to temperature.

Sensor monitoring

The removal of, or a fault in, a temperature sensor is detected. Should this happen all fans monitored by this sensor run at maximum speed, to achieve the greatest possible protection of the hardware.

Voltage monitoring

The most important voltages are monitored. When a voltage exceeds warning level high or falls below warning level low an alert will be generated. Adequate measurements can be done by running agents.

Cover monitoring

Unauthorised opening of the cover is detected, even when the system is switched off. However, this will only be indicated when the system is switched on again

System Event Log (SEL)

All monitored events of the system board are recorded in the System Event Log. They could be retrieved after a system reboot via ServerView.

3.6 Connectors and jumpers

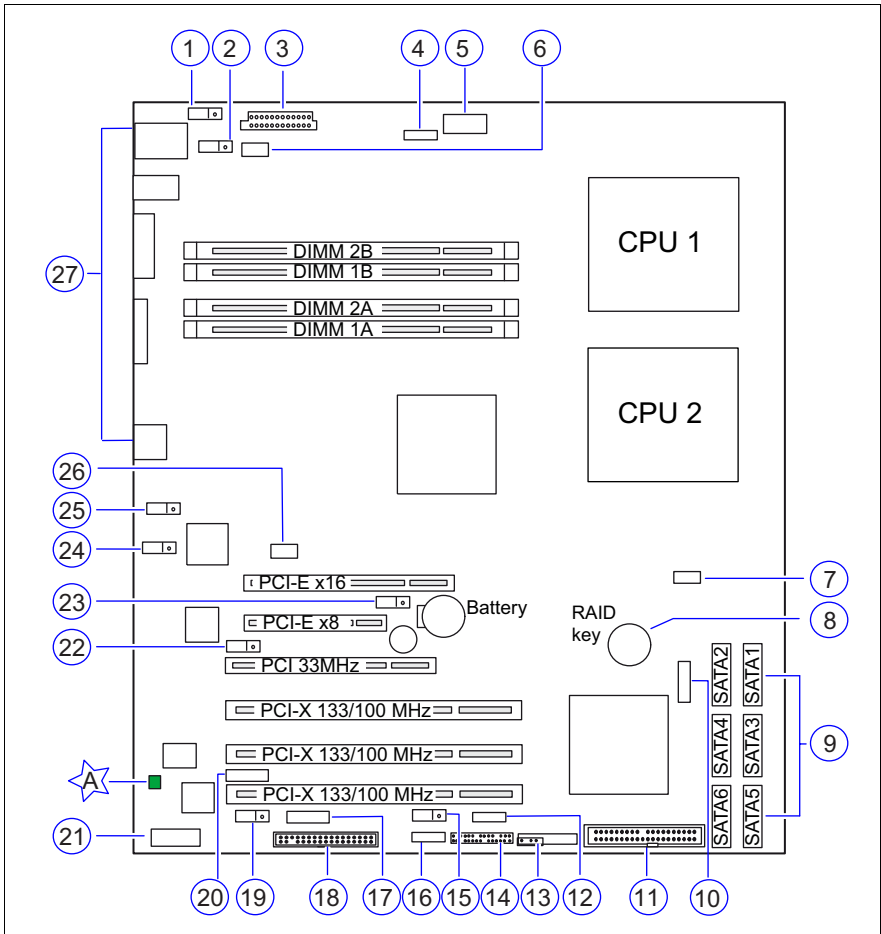

Figure 4: Schematic overview of the system board D2530

- | | |
|-----------------------------------|-------------------------|
| 1 = KBPWR (jumper) | 15 = USBPW 3/4 (jumper) |
| 2 = USBPW 1/2 (jumper) | 16 = USB 3/4 |
| 3 = power supply ATX | 17 = BPSMB |
| 4 = PC98 | 18 = floppy disk |
| 5 = power supply 12V (CPU1, CPU2) | 19 = BIOSREC (jumper) |
| 6 = CPU1 fan | 20 = COM2 |

7 = CPU2 fan	21 = LPT1
8 = RAID key	22 = VGA_EN (jumper)
9 = SATA 1 - 6	23 = CLRTC (jumper)
10 = USB 7/8	24 = LAN_EN (jumper)
11 = IDE primary	25 = LAN_BW (jumper)
12 = HDLED	26 = rear fan
13 = intrusion	27 = external connectors
14 = front panel	A = 5V Standby LED

Settings with jumpers

The system board is supplied with all jumpers set on default position (pin 1-2).

KBPWR (1)

- 1-2 PS/2 keyboard/mouse powered by 5V (default)
- 2-3 PS/2 keyboard/mouse powered by 5V Standby

USBPW 1/2 (2) and USBPW 3/4 (15)

- 1-2 USB device powered by 5V (default)
- 2-3 USB device powered by 5V Standby

BIOSREC (19)

- 1-2 system BIOS (default)
- 2-3 recover system BIOS (Flash BIOS, Recovery Diskette required)

VGA_EN (22)

- 1-2 onboard VGA enabled (default)
- 2-3 onboard VGA disabled (PCI VGA graphics controller)

CLRTC (23)

- 1-2 CMOS/RTC settings are not cleared (default)
- 2-3 clear CMOS/RTC settings

LAN_EN (24)

- 1-2 onboard LAN enabled (default)
- 2-3 onboard LAN disabled (PCI LAN controller)

LAN_BW (25)

- 1-2 LAN bandwidth setting to balanced mode (default)
- 2-3 LAN bandwidth setting to centric mode

LED**5V Standby(A)**

- lightning green standby power present
- off AC loss or system board not connected to power supply unit

3.6.1 External connectors

Figure 5: External connectors of the system board D2530

- | | |
|------------------------|----------------------|
| 1 = PS/2 mouse port | 4 = Serial port COM1 |
| 2 = PS/2 keyboard port | 5 = VGA port |
| 3 = USB port 1/2 | 6 = LAN port |

LAN connector

On this system board you will find a LAN controller integrated in the Intel® 6321 I/O controller Hub (ICH). This controller is supported by an external chip (Intel® Single 1 GB PHY 82564EB), which is connected to the I/O controller Hub via an original Intel interface (Kumeran Interface). The LAN controller supports the transfer rates of 10 Mbit/s, 100 Mbit/s and 1 Gbit/s and supports WOL function through Magic Packet™.

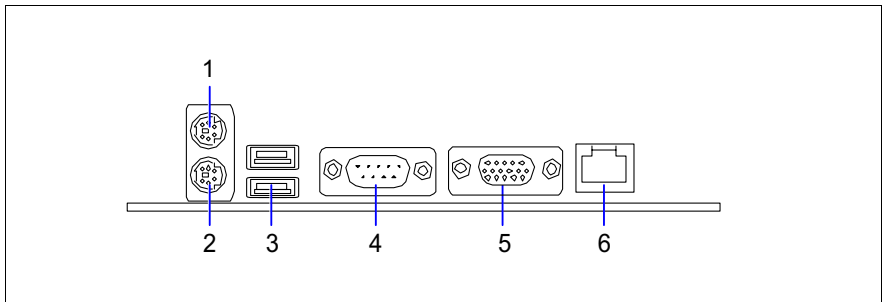
It is also possible to boot a device without its own boot hard disk via LAN. Here Intel PXE is supported.

The LAN controller connector is equipped with two LEDs (light emitting diode) indicating the transfer rate and the activity.

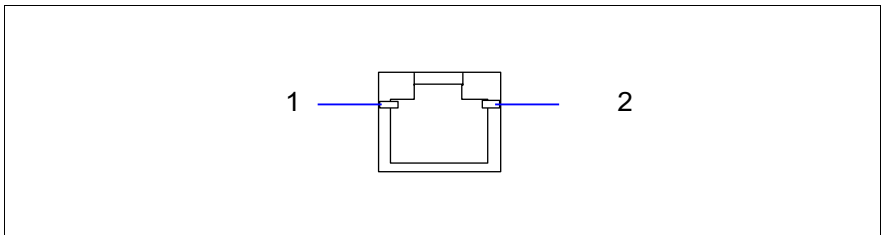

Figure 6: LAN connector

1	LAN link/activity	green	on	LAN connection
			off	no LAN connection
			flashing	LAN transfer
2	LAN transfer rate	green + orange	off	transfer rate 10 Mbit/s (or no connection)
		green	on	transfer rate 100 Mbit/s
		orange	on	transfer rate 1000 Mbit/s

4 Replacing the lithium battery

In order to save the system information permanently, a lithium battery is installed to provide the CMOS-memory with a current. When the charge is too low or the battery is empty, a corresponding error message is provided. The lithium battery must then be replaced.



The lithium battery must be replaced with an identical battery or a battery type recommended by the manufacturer (CR2032).

Do not throw lithium batteries into the trashcan. It must be disposed of in accordance with local regulations concerning special waste.

Make sure that you insert the battery the right way round. The plus pole must be on the top!

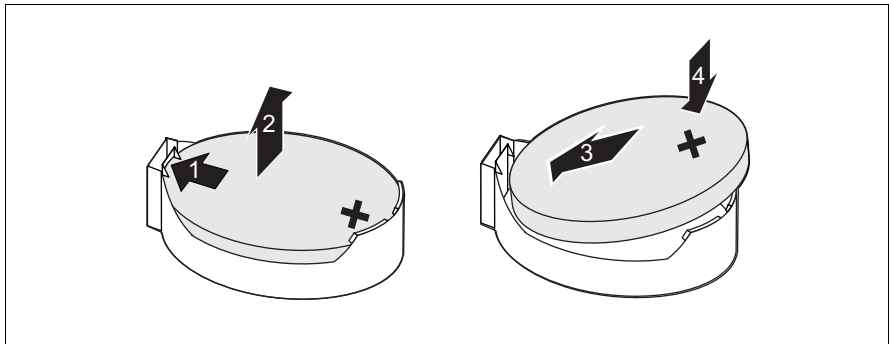

Figure 7: Replacing the lithium battery

- ▶ Press the locking spring into direction of of the arrow (1), so that the lithium-battery jumps out of its socket.
- ▶ Remove the battery (2).
- ▶ Insert a new lithium battery of the same type into the socket (3) and (4).

Abbreviations

The technical terms and abbreviations given below represent only a selection of the full list of common technical terms and abbreviations.

Not all technical terms and abbreviations listed here are valid for the described system board.

AC

Alternating Current

ACPI

Advanced Configuration and Power management Interface

ANSI

American National Standards Institute

ASR&R

Automatic Server Recovery and Restart

ATA

Advanced Technology Attachment

BBU

Battery Backup Unit

BIOS

Basic Input Output System

BMC

Baseboard Management Controller

CMOS

Complementary Metal Oxide Semiconductor

COM

COMmunication port

CPU

Central Processing Unit

Abbreviations

DDR

Double Data Rate

DIMM

Dual In-line Memory Module

DIP

Dual In-line Package

DMI

Desktop Management Interface

DRAM

Dynamic Random Access Memory

ECC

Error Correction Code

EEPROM

Electrical Erasable Programmable Read Only Memory

EFI

Extensible Firmware Interface

EGB

Elektrostatisch gefährdete Bauteile

EHCI

Enhanced Host Controller Interface

EMI

Electromagnetic interference

EMRL

Embedded RAID Logic

EMV

Elektromagnetische Verträglichkeit (electromagnetic compatibility)

EPROM

Erasable Programmable Read Only Memory

ESD
ElectroStatic Discharge (elektrostatische Entladung)

EVRD
Enterprise VRD

HPC
Hotplug Controller

FPC
Front Panel Controller

FRU
Field Replaceable Unit

FSB
Front Side Bus

ICE
In Circuit Emulation

IDE
Integrated (intelligent) Drive Electronics

IEC
International Electrotechnical Commission

IME
Integrated Mirroring Enhanced

IOOP
Intelligent Organisation Of PCI

IPMB
Intelligent Platform Management Bus

IPMI
Intelligent Platform Management Interface

iRMC
integrated Remote Management Controller

Abbreviations

ISO

International Organisation for Standardisation

LAN

Local Area Network

LED

Light Emitting Diode

MPS

Multi Processor Specification

NMI

Non Maskable Interrupt

OEM

Original Equipment Manufacturer

OHCI

Open Host Controller Interface

OS

Operating System

PCI

Peripheral Components Interconnect

PDA

Prefailure Detection and Analyzing

PIO

Programmed Input Output

PDB

Power Distribution Board

PLD

Programmable Logic Device

PS(U)

Power Supply (Unit)

PWM

Pulse Wide Modulation

PXE

Preboot eXecution Environment

RAID

Redundant Array of Inexpensive Disks

RoHS

Restriction of the Use of Certain Hazardous Substances (Waste from Electric and Electronic Equipment, EU Directive)

RoMB

RAID on Motherboard

RSB

Remote Service Board

RST

ReSeT

RTC

Real Time Clock

SAS

Serial Attached SCSI

SATA

Serial ATA

SCSI

Small Computer Systems Interface

SDDC

Single Device Data Correction

SDRAM

Synchronous Dynamic Random Access Memory

SEL

System Event Log

Abbreviations

SHDG

Server Hardware Design Guide

SMB

System Management Bus

SMM

Server Management Mode

SMP

Symmetrical Multi Processing

UHCI

Unified Host Controller Interface

USB

Universal Serial Bus

VGA

Video Graphics Adapter

VRD

Voltage Regulator Down

VRM

Voltage Regulator Module

WEEE

Waste from Electric and Electronic Equipment (EU Directive)

WfM

Wired for Management

WOL

Wake up On LAN

Fujitsu Siemens Computers GmbH
User Documentation
81730 München
Germany

Comments
Suggestions
Corrections

Fax: (++49) 700 / 372 00000

e-mail: manuals@fujitsu-siemens.com
<http://manuals.fujitsu-siemens.com>

Submitted by

Comments on System Board D2530
for Econel 200 S2



